

# Miele

TOUCHTRONIC 

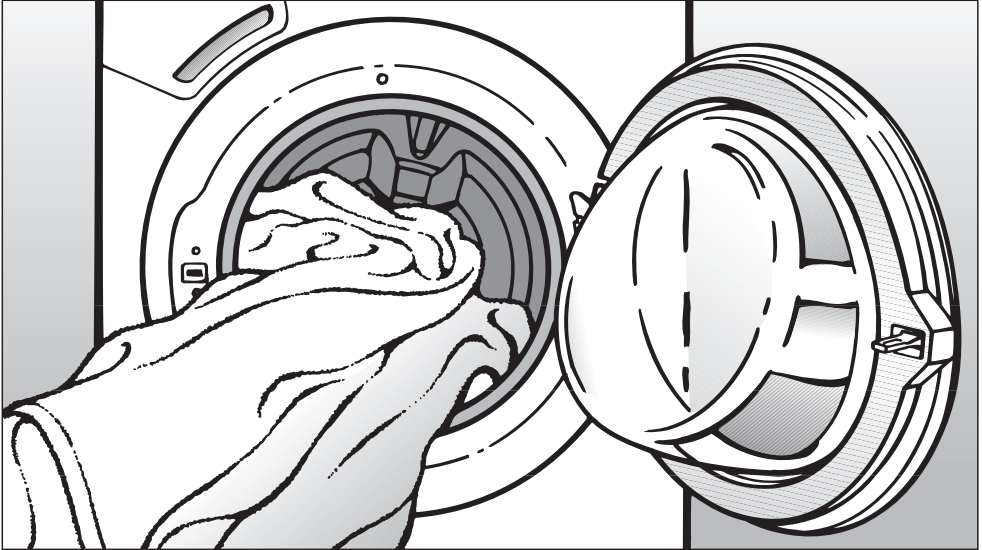

## Operating and Installation Instructions Washer W 4840

To prevent accidents and  
machine damage,  
read these instructions  
**before** installation or use.

en - US, CA

M.-Nr. 06 982 281

# Contents

---

<b>IMPORTANT SAFETY INSTRUCTIONS</b> . . . . .	4
<b>Guide to the washer</b> . . . . .	6
Control panel . . . . .	6
Display function . . . . .	7
<b>Before using for the first time</b> . . . . .	8
Setting the display language . . . . .	8
<b>Using the washer</b> . . . . .	9
1. Prepare and sort the laundry . . . . .	9
2. Load the laundry . . . . .	10
Loading a comforter . . . . .	11
3. Select a program . . . . .	12
4. Select a temperature and/or spin speed . . . . .	12
Program guide . . . . .	13
Final spin speed . . . . .	17
5. Select an option . . . . .	18
6. Add detergent . . . . .	19
Detergents . . . . .	21
Fabric after care . . . . .	22
7. Select Delay Start (if desired) . . . . .	23
8. Start the program . . . . .	24
9. Activate the Child Lock (if desired) . . . . .	24
10. Program end . . . . .	25
Canceling a program . . . . .	26
Interrupting a program . . . . .	26
Changing a program . . . . .	26
Adjusting the temperature . . . . .	26
Adjusting the spin speed . . . . .	26
Adjusting the options . . . . .	26
<b>Quick guide</b> . . . . .	27

<b>Using the washer</b> . . . . .	27
Adding/removing laundry during a wash program . . . . .	27
<b>Cleaning and Care</b> . . . . .	28
Cleaning the exterior and control panel . . . . .	28
Cleaning the drum . . . . .	28
Cleaning the detergent drawer . . . . .	29
Cleaning the water inlet filters . . . . .	30
<b>Frequently asked questions</b> . . . . .	31
A wash program cannot be started . . . . .	31
The display shows a fault message . . . . .	32
General problems with the washer . . . . .	33
Unsatisfactory wash results . . . . .	34
The drum door cannot be opened . . . . .	35
<b>After sales service</b> . . . . .	38
<b>Installation instructions</b> . . . . .	39
<b>Installation</b> . . . . .	40
Installation site . . . . .	42
Removing the shipping struts . . . . .	43
Leveling the washer . . . . .	44
<b>Plumbing</b> . . . . .	45
Water connection . . . . .	46
Drainage . . . . .	47
<b>Electrical connection</b> . . . . .	48
<b>Setting the display language</b> . . . . .	49
<b>Help protect our environment</b> . . . . .	50

# IMPORTANT SAFETY INSTRUCTIONS

---

 **WARNING** - To reduce the risk of fire, electric shock or injury to persons while using your appliance follow basic safety precautions, including the following:

▶ Read all instructions before using the appliance.

## ▶ GROUNDING INSTRUCTIONS

This appliance must be grounded. In the event of malfunction or breakdown, grounding will reduce the risk of electric shock by providing a path of least resistance for electric current. This appliance is equipped with a cord having an equipment-grounding conductor and a grounding plug. The plug must be plugged into an appropriate outlet that is properly installed and grounded in accordance with all local codes and ordinances.

▶ **WARNING** - Improper connection of the equipment-grounding conductor may result in a risk of electric shock. Check with a qualified electrician if you are in doubt as to whether the appliance is properly grounded.

▶ Do not modify the plug provided with the appliance - if it will not fit the outlet, have a proper outlet installed by a qualified electrician.

▶ Before connecting the machine, ensure that the connection data on the data plate (fusing, voltage and frequency) match the mains electrical supply. If in doubt contact an electrician.

▶ Do not use an extension cord to connect this appliance to the power supply. Extension cords do not guarantee the required safety of the appliance (e.g. danger of overheating).

▶ Do not install your washing machine in rooms where temperatures below freezing may occur. Frozen hoses may burst under pressure. The reliability of the electronic control unit may be impaired at temperatures below freezing.

▶ Do not install or store this appliance where it will be exposed to the weather.

▶ This appliance is not designed for maritime use or for use in mobile installations such as recreational vehicles or aircraft. However, under certain conditions it may be possible for an installation in these applications. Please contact the Miele Technical Service Dept. with specific requirements.

▶ Do not install or use a washer with visible damage.

▶ Do not repair or replace any part of the appliance or attempt any servicing unless specifically recommended in these operating instructions.

# IMPORTANT SAFETY INSTRUCTIONS

- ▶ Faulty components must only be replaced with genuine Miele spare parts.
- ▶ If the power cord is damaged it must only be replaced by a Miele Service technician with a genuine Miele power cord.
- ▶ Under certain conditions, hydrogen gas may be produced in a hot water system that has not been used for 2 weeks or more. **HYDROGEN GAS IS EXPLOSIVE.** If the hot water system has not been used for such a period, turn on all hot water faucets and let the water flow from each for several minutes before using the washing machine. This will release any built-up hydrogen gas. Do not smoke or use an open flame during this time, the gas is flammable.
- ▶ Before the appliance is removed for service or discarded, remove the door.

## Use

- ▶ Do not allow children to play on or in the appliance. Close supervision is necessary when the appliance is used near children.
- ▶ The drum door glass will be hot when washing at very high temperatures. Do not touch the glass. Danger of burns! Keep children away from the washer when in use.

- ▶ Only use the washing machine to wash items which are specified by the manufacturer to be machine washable on the fabric care label. Any other applications may be dangerous. The manufacturer cannot be held responsible for damage caused by improper use of the appliance.
- ▶ Do not wash articles that have been previously cleaned, washed, soaked or spotted with gasoline, dry-cleaning solvents or other flammable substances. These articles give off vapors that could ignite or explode. Do not add these items to the wash load.
- ▶ Do not add gasoline, dry-cleaning solvents, or other flammable or explosive substances to the wash water. These substances give off vapors which could ignite or explode.
- ▶ Do not use cleaning solvents on or near the machine or the controls. Contact with cleaning solvents will damage the surface.
- ▶ Do not reach into the appliance if the drum is moving.
- ▶ Do not tamper with the controls.
- ▶ The control panel must only be exchanged or removed by an authorized Miele Service Technician. If the control panel is not professionally exchanged there is a danger of electric shock and the machine may be damaged.

**SAVE THESE  
INSTRUCTIONS**

# Guide to the washer

## Control panel

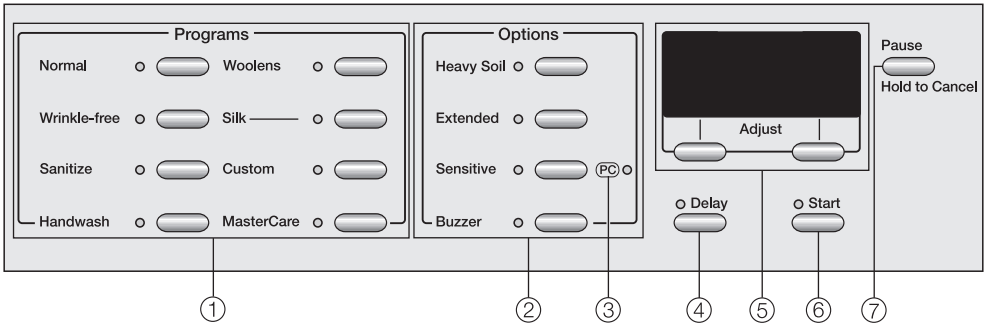

① **Program buttons**

To select a wash program.

② **Option buttons**

Special features to enhance a wash program.

③ **PC Indicator**

Allows a service technician to check and update the wash programs.

④ **Delay Start button**

To delay the start of a program.

⑤ **Display with menu buttons**

See "Display function" for more information.

⑥ **Start**

Starts the selected wash program.

⑦ **Pause button**

Pauses or cancels a program.

## Display function

The display allows you to operate and select various functions of the washer.

### Selection and display of program settings

- Temperature selection
- Spin speed selection
- Delay start
- Display of an approximate program running time

### Program selection using the display

By pressing the "MasterCare" button, you can select from the following programs:

- Extra White
- Delicates
- Denim / Jeans
- Dress shirts
- Comforters
- Outerwear
- Table linens
- Beach towels
- Express
- Drain / Spin
- Quick rinse

## "Menu" buttons

Various settings can be made with the "Menu" buttons.

The values above the vertical line can be adjusted and/or confirmed.

Example:



Pressing the left menu button "**Warm**" allows to adjust the temperature. The "**High spin**" button allows you to adjust the spin speed.

Example:



With the "▼" button additional programs can be selected and confirmed with the "**OK**" button.

## Before using for the first time

---

The appliance must be correctly installed and connected before the first use. Please see the "Installation instructions."

This washing machine has undergone thorough functional testing in the factory, there may be some residual water in the drum from this process.

Running a spin cycle before the first use is, for safety reasons, not possible. To activate the spin cycle a wash program must be run **without laundry or detergent**.

- Turn on the water supply.

The Welcome screen shows once the washer is turned on for the first time.

The Welcome screen will not show after the washer has run for more than 1 hour.

The display now shows the language setting.

### Setting the display language

The default setting for the display language is **German**. The display language can be adjusted.



- Select the desired language by pressing the left menu button "◀". Confirm the setting with the right "OK" button.

### Shipping strut reminder

The shipping struts must be removed before the first use to avoid machine damage.

- Confirm that the shipping struts have been removed by pressing "OK".

The washer is now ready for the first use.

### Starting the first wash program

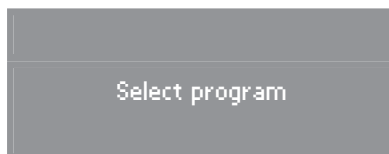

- Press the program button "Sanitize".
- Press the "Start" button.

Once the program has finished the first use is complete. The washer can be used.



## 1. Prepare and sort the laundry

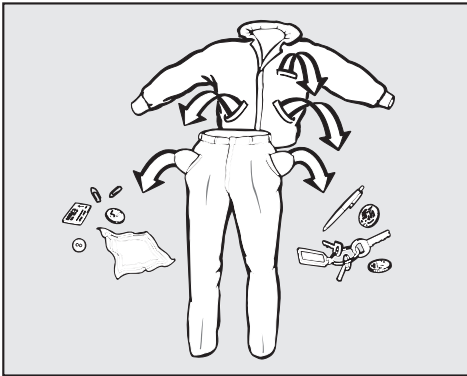

- Empty all pockets.

 Foreign objects left in pockets (e.g. nails, coins, paper clips, etc.) can cause damage to clothes and the machine.

### Pretreat stains

- Tough stains (blood, egg, coffee, tea, etc.) or badly soiled areas (collars and cuffs) should be pretreated with a stain remover or a paste made from powder detergent and warm water. Dab stains with a damp light colored cloth. Do not rub!

 Do not use chemical solvents in the machine.

## Sort the laundry

- Only wash items that are labeled machine washable by the manufacturer. Most garments have a fabric care label in the collar or side seam.
- Sort the laundry by care label and color.

## General tips

- Dark fabrics often bleed the first few times they are washed. They should be washed separately several times before being included in a mixed load.
- Curtains: Remove any lead weights or strips before washing.
- Loose bra underwires should be removed or sewn in place before washing.
- Woolens, knitted garments, jeans, pants and sweat shirts should be turned inside out.
- Close zippers, hooks and eyelets before washing.
- Comforter covers and pillowcases should be fastened to prevent small items from rolling inside of them.
- **Do not** wash items with the  symbol on the fabric care label.

# Using the washer

## 2. Load the laundry

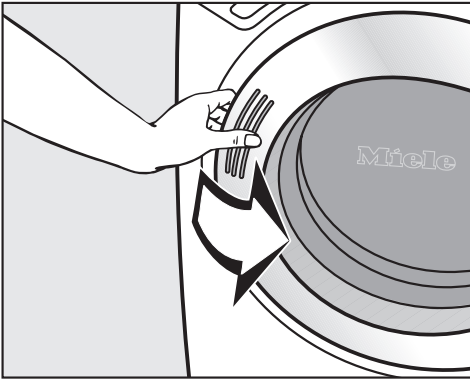

- Open the drum door.
- Load the laundry loosely in the drum. For best results, wash mixed loads of small and large items. This will improve washing effectiveness and help distribute the load evenly.

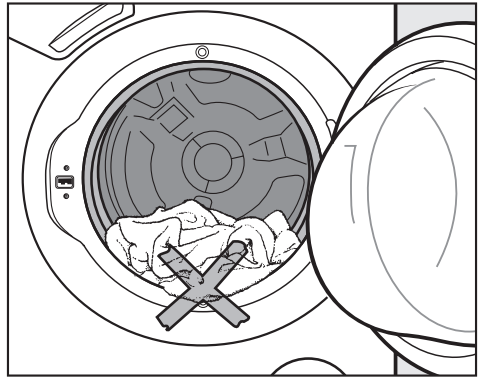

- Close the drum door. To prevent damage make sure that there are no clothes caught between the drum door and seal.

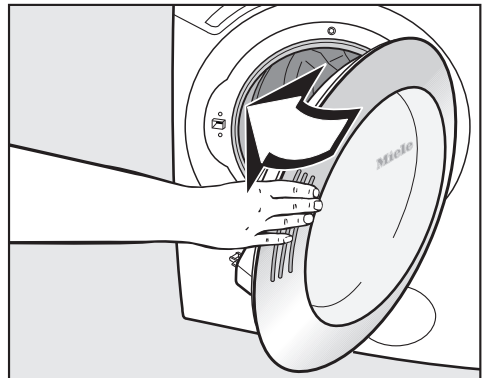

- Close the drum door.

## Loading a comforter

"Full size" comforters can be washed up to 84" x 88" / 213 x 224 cm.

Make sure to load the comforter correctly to avoid damage.

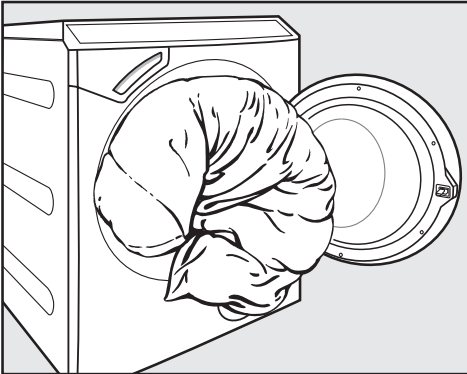

- Fold the comforter and load into the washer.
- Turn the comforter in the drum so that a smooth surface forms facing the door when the comforter is completely loaded.

 Make sure that the comforter does not touch the rubber door seal and that all corners are tucked in.

## Comforter loaded correctly

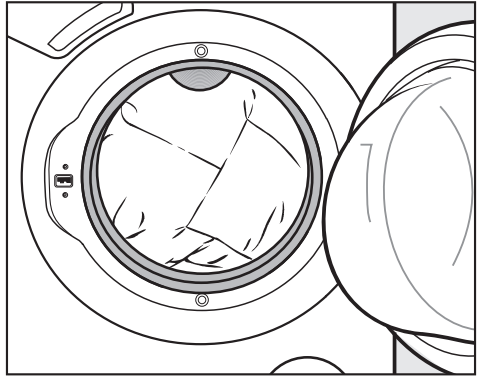

## Comforter loaded incorrectly

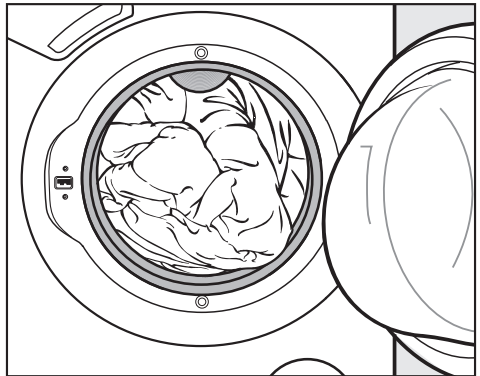

# Using the washer

## 3. Select a program

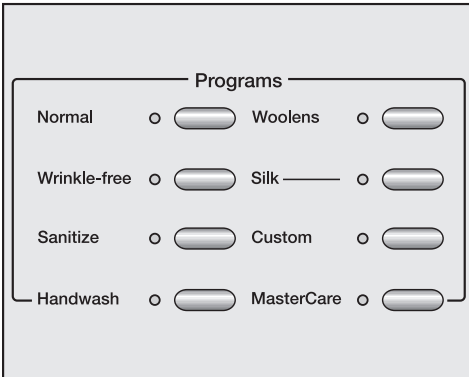

- Press the button of the desired program.

The indicator of the selected program lights.

## 4. Select a temperature and/or spin speed

The preselected temperature and/or spin speed can be adjusted if the program allows for it. See the "Program guide".



By pressing the left menu button "**Warm**", the temperature will be adjusted. Pressing the right menu button "**High spin**" will adjust the spin speed.

If "MasterCare" is selected a list will appear in the display.















- With the left menu button "▼" additional programs can be selected and then confirmed with the right menu button "**OK**".



- If desired and allowed by the program, adjust the temperature with the left menu button and spin speed with the right menu button.

## Program guide











Temperature		Final spin	Item / Tip
<b>Normal</b>	Options: Heavy Soil, Extended, Sensitive, Buzzer		
Hot		<b>High spin</b>	Items made from cottons, linen or mixed fabrics.  <b>Important:</b> Fill the drum only $\frac{3}{4}$ of the way. Items need room to move otherwise they might get caught in the drum door seal.
Very Warm			
<b>Warm</b>			
Cold			
No Heat			
<b>Wrinkle free</b>	Options: Heavy Soil, Extended, Sensitive, Buzzer		
Hot		<b>High spin</b> Med spin	Items made from synthetics, mixed fabrics or wrinkle free cottons.
Very Warm			
Warm			
<b>Cold</b>			
No Heat			
<b>Sanitize</b>	Options: Heavy Soil, Extended, Sensitive, Buzzer		
<b>Sanitize</b>		<b>Max spin</b> High spin	Items which have skin contact or for special hygienic requests.
Hot			
<b>Handwash</b>	Options: Heavy Soil, Extended, Sensitive, Buzzer		
Warm		<b>Med spin</b>	Hand washable items which do not contain wool or silk.
<b>Cold</b>			
No Heat			

The default settings are highlighted in **bold**.



# Using the washer

Temperature		Final spin	Item / Tip
<b>Woolens</b>		Options: Sensitive, Buzzer	
Warm		<b>High spin</b> Med spin Slow spin Hold No spin	Items made from washable wool or mixed woolens.
<b>Cold</b>			
No Heat			
<b>Silk</b>		Options: Buzzer	
<b>Cold</b>		<b>Slow spin</b>	Silk and hand washable items which do not contain wool.
No Heat			
<b>Custom</b>		Options: Heavy Soil, Extended, Sensitive, Buzzer	
<b>Sanitize</b>		<b>Max spin</b> High spin Med spin Slow spin Hold No spin	All options are selectable for "Sanitize" and "Normal" programs.
Hot			
Very Warm			
Warm			
Cold			
No Heat			
<b>Extra White</b>		Options: Heavy Soil, Extended, Sensitive, Buzzer	
<b>Hot</b>		<b>Max spin</b>	For white items without special hygienic requests.
Very Warm			

# Using the washer

Temperatures		Final spin	Item / Tip
<b>Delicates</b>	Options: Extended, Sensitive, Buzzer		
Warm		<b>Med spin</b> Slow spin Hold No spin	For delicate items made from synthetics.
<b>Cold</b>			
No heat			
<b>Denim/Jeans</b>	Options: Heavy Soil, Extended, Sensitive, Buzzer		
<b>Warm</b>		<b>High spin</b> Med spin	All items made from denim. Before washing denim items turn them inside out.
Cold			
No heat			
<b>Dress shirts</b>	Options: Heavy Soil, Sensitive, Buzzer		
<b>Warm</b>		<b>Med spin</b> Slow spin Hold No spin	Pretreat collars and cuffs depending on soiling.
Cold			
No heat			
<b>Comforters</b>	Options: Heavy Soil, Extended, Sensitive, Buzzer		
<b>Warm</b>		<b>High spin</b> Med spin Slow spin	Comforters and pillows
Cold			
No heat			
<b>Outerwear</b>	Options: Buzzer		
<b>Cold</b>		<b>Med spin</b>	Close all zippers. Do not use fabric softener.
<b>Table linens</b>	Options: Heavy Soil, Extended, Sensitive, Buzzer		
<b>Warm</b>		<b>High spin</b> Med spin Slow spin Hold No spin	For tablecloths and napkins.
Cold			
No heat			

# Using the washer

Temperature		Final spin	Item / Tip
<b>Beach towels</b> Options: Buzzer			
No Heat		<b>Max spin</b>	Program to rinse sand from beach towels. Do not use detergent.
<b>Express</b> Options: Buzzer			
Warm		<b>Max spin</b> High spin Med spin Slow spin Hold No Spin	Small loads of mixed items for the programs "Normal" and "Wrinkle free".
Cold			
No Heat			
<b>Drain / Spin</b> Options: Buzzer			
		<b>Max spin</b> High spin Med spin Slow spin No Spin	
<b>Quick rinse</b> Options: Buzzer			
		<b>High spin</b> Med spin Slow spin Hold No Spin	



## Final spin speed

Program	
Normal	High spin
Wrinkle-free	High spin
Sanitize	Max spin
Handwash	Med spin
Woolens	High spin
Silk	Slow spin
Custom	Max spin
Extra White	Max spin
Delicates	Med spin
Denim/Jeans	High spin
Dress shirts	Med spin
Comforters	High spin
Outerwear	Med spin
Table linens	High spin
Beach towels	Max spin
Express	Max spin
Drain/Spin	Max spin
Quick rinse	High spin

The final spin speed can be reduced, if the program allows changes. The selection of a final spin speed higher than that shown above is not possible.

## Rinse spin

The laundry is spun after the main wash and between the rinse cycles. Reducing the final spin speed will also reduce the rinse spin speeds.

### Hold

- Select "Hold".

The laundry is not spun and remains soaking in water. This will prevent wrinkles if the laundry is not removed immediately at the end of the wash program.

- Selecting/Starting the final spin

The washer is set default to the maximum spin speed of the wash program. You can select a lower spin speed if desired.

- Press "Start" to start the final spin.

- To finish the program

- Press and hold the "Pause" button until the program ends.

### No spin (Deselect rinse spin and final spin)

- Select "No spin". The laundry is not spun after the final rinse, but the water is drained away. After the drain cycle the washer goes immediately into the anti-crease cycle.

# Using the washer

## 5. Select an option

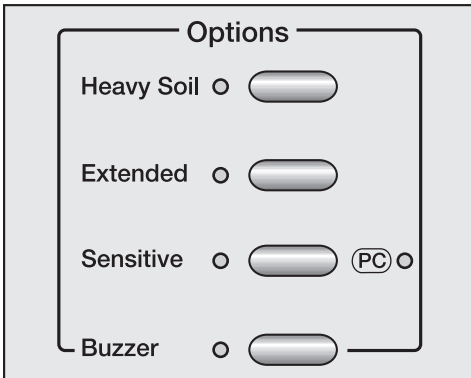

- Select the desired Option with the respective button. Once an Option is selected, the indicator lights.

See the "Program Guide" to determine which Option is selectable for each program.

If an Option cannot be selected, the wash program does not permit it.

### Heavy Soil

For heavily soiled laundry or stubborn dried on stains.

A pre-wash takes place and the wash time for the main wash is extended.

### Extended

For laundry with normal to heavy soiling or stains.

The main wash cycle time for the wash program is extended.

### Sensitive

An additional final rinse washes away detergent residue and scents.

An additional rinse takes place.

### Buzzer

A buzzer signals the end of the wash program or after "Hold". The buzzer sounds until the washer is turned off. The buzzer volume can be adjusted.

### Adjusting the buzzer volume

No program is selected.

- Press the "Buzzer" button until the display shows:



- Press the left menu button "⏪" to adjust the buzzer volume. Confirm with "OK".

## 6. Add detergent

Front loading washing machines require significantly less detergent than traditional top loaders. Closely follow the requirements of the detergent manufacturer.

Use detergent according to the laundry soiling and water hardness.

### **Light soiling**

No soiling or stains are visible.

### **Normal soiling**

Some visible soiling or a few light stains.

### **Heavy soiling**

Very visible soiling or stains.

Use the "Heavy soil" function and add detergent in the Heavy soil compartment as described.

### **Too little detergent may cause:**

- Ineffective cleaning of laundry; fabrics may become gray and stiff over time.
- Grease stains on the laundry.
- Hard water deposits on the heating element.

### **Too much detergent may cause:**

- Oversudsing with minimal drum movement; poor wash, rinse and spin results.
- Higher water consumption through an automatic, additional rinse cycle.
- Higher environmental burden.

## Using the washer

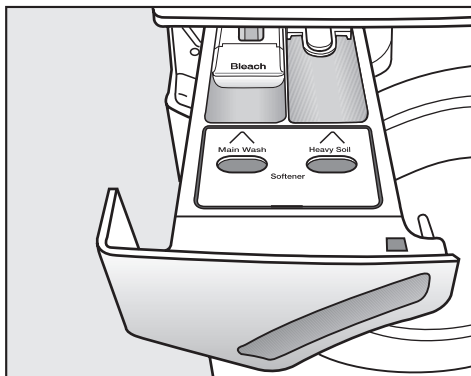

- Pull out the detergent dispenser drawer.

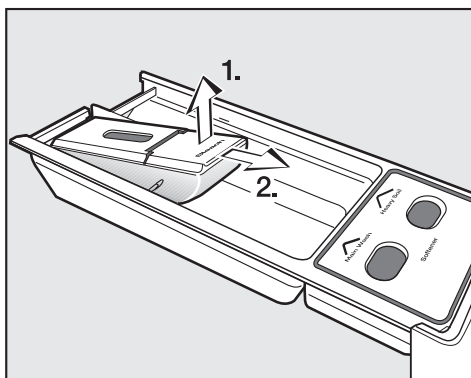

- If you do not use bleach, please remove the insert from the main wash compartment.

- Add detergent to the desired compartments.
  - **Main wash**  
Detergent for the main wash
  - **Heavy Soil**  
Detergent for the pre-wash
  - **Bleach**  
Bleach used as described by the manufacturer; placed in the bleach compartment
  - **Softener**  
Fabric softener or liquid starch
- Add detergent to the Main Wash compartment at the beginning of each wash program.
- Only add detergent ( $\frac{1}{4}$  total recommended amount) to the "Heavy Soil" compartment, if the "Heavy Soil" option was selected.
- Close the detergent drawer.

## Detergents

You can use all **high efficiency detergents** which are formulated for household washing machines. Closely follow the requirements of the detergent manufacturer.

	<b>Universal</b>	<b>Color</b>	<b>Delicate</b>	<b>Bleach</b>
Normal	X	X		X
Wrinkle-free	X	X		X
Sanitize	X			X
Handwash			X	
Woolens	Detergent for wool			
Silk			X	
Custom	X	X		X
Extra White	X			X
Delicates			X	X
Denim/Jeans		X <sup>1)</sup>		X
Dress shirts	X	X		X
Comforters			X	X
Outerwear			X	X
Table linens	X			X
Beach towels	Do not use detergent with this program			
Express	X	X		

<sup>1)</sup> only liquid detergent

# Using the washer

## Fabric after care

### Fabric softener

Makes fabrics feel softer and reduces static cling in the dryer.

### Mild liquid starch

A synthetic starch wash that gives fabrics some stiffness.

### Starch

Gives the fabrics stiffness and volume.

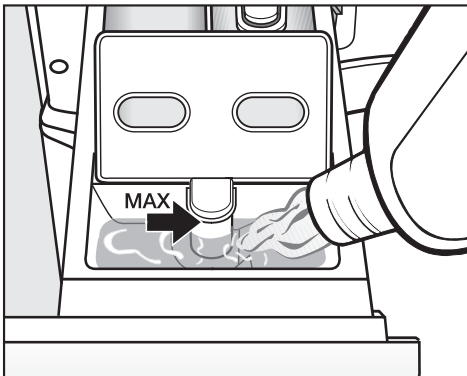

- Add the fabric softener or mild liquid starch to the "Softener" compartment.

**Do not exceed the maximum fill level marked inside the compartment.**

The fabric softener / liquid starch will be dispensed during the final rinse. A small amount of water will remain in the compartment at the end of the program.

If starching frequently, clean the dispenser compartment and especially the siphon tube.

## Bleach

To remove difficult to clean stains

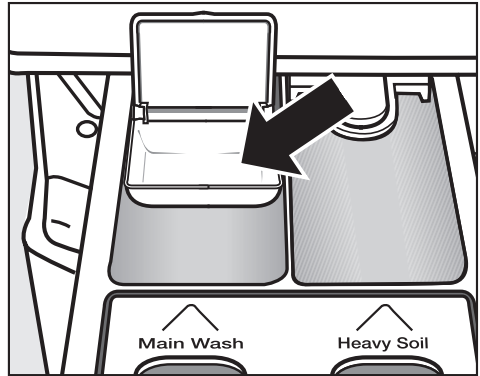

- Pour bleach into the bleach compartment.

During the Main Wash the bleach will be automatically rinsed from the compartment and added to the cycle.

## Dyes / Dye removers

The use of dyes in the washer is recommended only to a degree of usual household use. The salt used for dyeing may corrode the stainless steel with frequent use.

- Use as directed by the manufacturer.

**⚠ Do not use dye removers in this washer!**

## 7. Select Delay Start (if desired)

Delay start allows you to delay the start of a program from 30 minutes to a maximum of 24 hours.

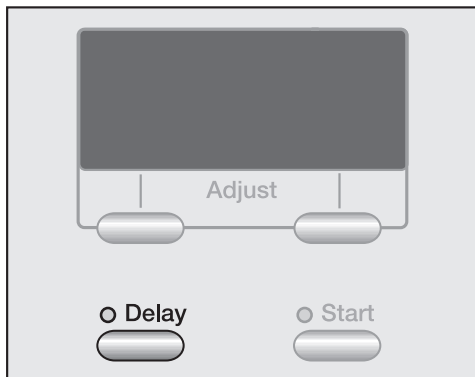

- Press the "Delay" button.



- With every touch of the "Delay" button, the start is delayed longer. Hold to speed up the count.
  - For a delay less than 10 hours, the delay time extends in 30 minute increments.
  - For a delay more than 10 hours, the delay time extends in 1 hour increments.

### Cancel

- Press the "Pause" button.

### Adjust

- To adjust the "Delay Start" time cancel then reset.

# Using the washer

## 8. Start the program



- Press the flashing "Start" button.

If a delay start is set, the remaining times elapses in the display. Once the delayed start time has elapsed or immediately after the program starts, the approximate program running time is displayed. The washer calculates the water absorbency of the laundry in the first 8 minutes. The overall program time may be shortened or lengthened.

Additionally the sequence cycle is displayed. The washer shows the current program step.

The drum door will be locked and the drum light will turn off once the program starts.

 If a program was started without detergent, cancel the program first. Add detergent, then select and start a program again.

## 9. Activate the Child Lock (if desired)

The Child Lock prevents a program from being canceled.

- Press and hold the "Heavy Soil" button until the display shows:



## Deactivate the Child Lock

- Press and hold the "Heavy Soil" button until the display shows:



Once the program has finished, the Child Lock must be deactivated.



## 10. Program end

The "Anti-crease" program displays

Anti-crease

alternating with:

End

- Open the drum door and remove the laundry.

Check the drum for any missed pieces of laundry. Items inadvertently left in the washer may be damaged (e.g. shrink or discolor) during the next wash cycle.

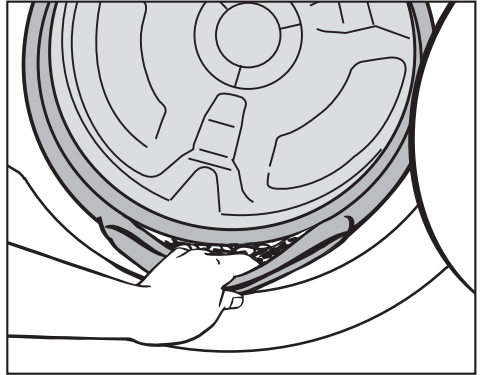

- Check the folds of the door seal for any small articles.
- Close the drum door.
- Activate the Child Lock so children or animals do not find their way into the drum.
- Shut off the water supply if the washer will not be used for a longer period of time, e.g. vacationing.

# Using the washer

---

## Canceling a program

A program can be canceled any time after the program start.

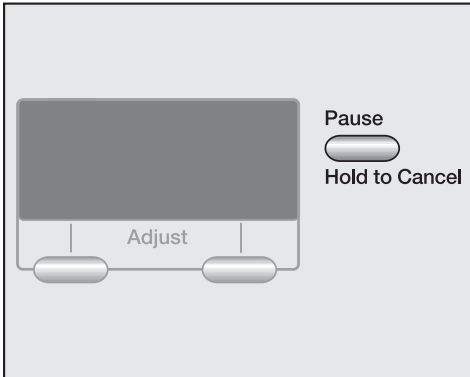

- Press and hold the "Pause" button until the display shows:

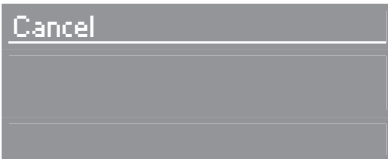

The wash water will be drained away.

## To add or remove laundry

- Open the drum door.

## To select another program

The display requests the program selection.

- Select the desired program.

## Interrupting a program

- Press the "Pause" button briefly.

The washer interrupts the program and unlocks the door.

To continue:

- Press the "Start" button.

## Changing a program

A program change is not possible once the program has started. The program must be canceled.

## Adjusting the temperature

The temperature can be changed up to 6 minutes after the program start.

## Adjusting the spin speed

The spin speed can be adjusted anytime up to the beginning of the final spin.

## Adjusting the options

The options "Extended" or "Sensitive" can be selected or deselected up to 6 minutes after the program start.

The "Buzzer" option can be selected or deselected at any time.

# Miele

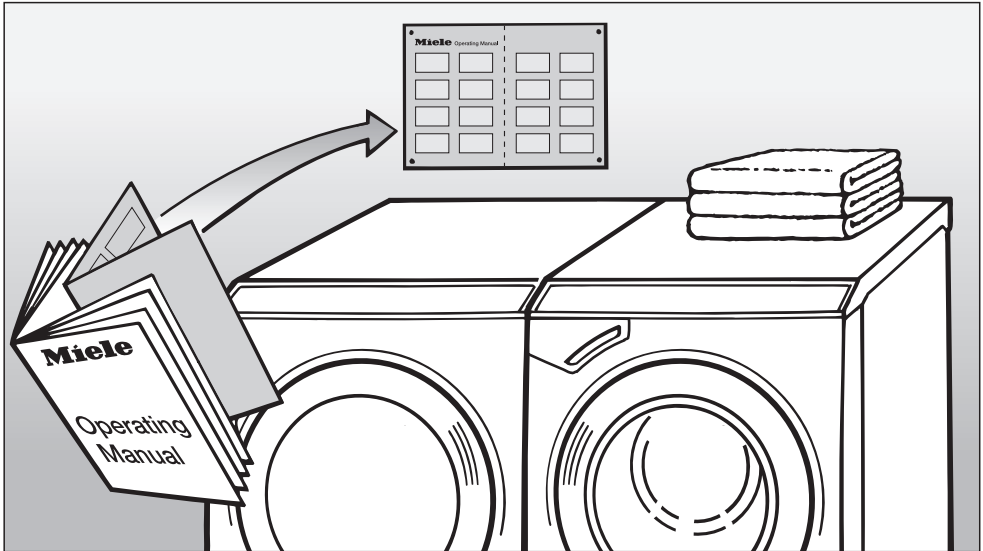

## Quick guide

**Remove this guide for easy reference**

Please read all instructions, especially the "Important Safety Instructions", before using the washer.

# Quick guide

## 1. Sort the laundry

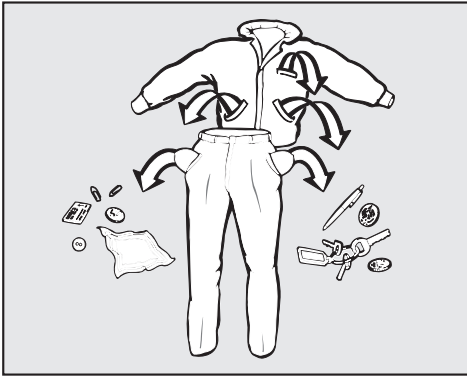

- Empty all pockets.
- Sort the laundry by fabric care label and color.
- Pretreat stains.

## 2. Load the laundry

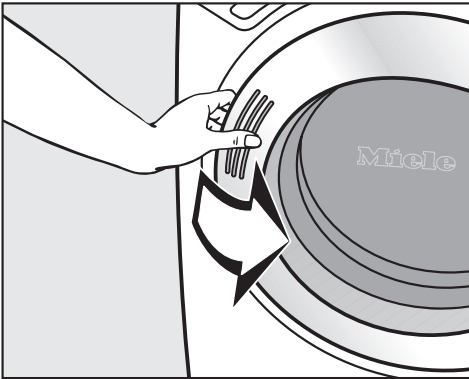

- Open the drum door and load the laundry.
- Close the drum door.

To prevent damage, make sure that no clothing is caught between the drum door and seal.

## 3. Select a program

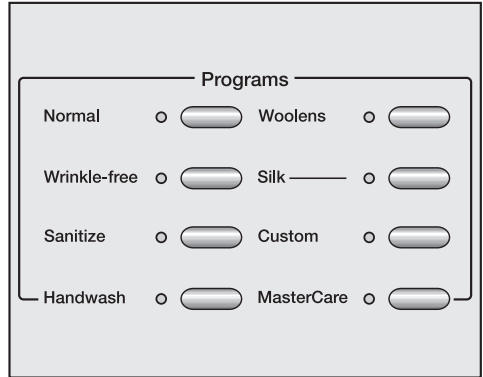

- Press the button of the desired program.

The indicator of the selected program lights.

## 4. Select a temperature

The preselected temperature and/or spin speed can be adjusted if the program allows.

Example:



By pressing the left menu button "**Warm**", the temperature will be adjusted. Pressing the right menu button "**High spin speed**" will adjust the spin speed.

## 5. Select an Option

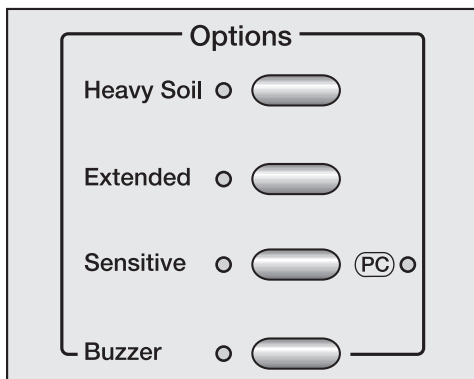

- Select the desired Option with the respective button. Once an Option is selected the indicator lights.

## 6. Add detergent

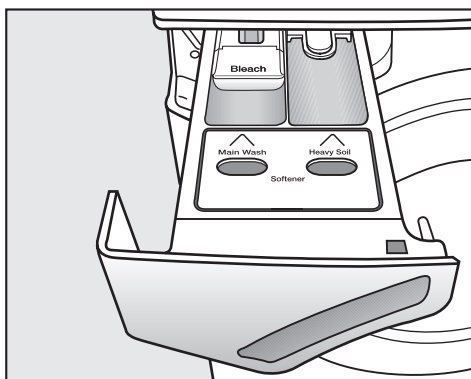

- Add detergent to the appropriate compartments.

## 7. Select Delay Start (if desired)

- Press the "Delay" button.



- With every touch of the "Delay" button, the start is delayed longer.

## 8. Start a program

- Press the flashing "Start" button.

## 9. Activate the Child Lock (if desired)

- Press the "Heavy soil" button until the display shows:



- Deactivate the Child Lock after the program has finished.

## 10. Unload the laundry

- Open the drum door.
- Remove the laundry.
- Shut off the water supply if the washer will not be used for a longer period of time, e.g. vacationing.

Check the drum for any missed pieces of laundry. Items inadvertently left in the washer may be damaged (e.g. shrink or discolor) during the next wash cycle.

# Quick guide

## Program guide

	Sanitize	Hot	Very warm	Warm	Cold	No heat	Max spin	High spin	Med spin	Slow spin	Hold	No spin
Normal		X	X	<b>X</b>	X	X		<b>X</b>				
Wrinkle-free		X	X	X	<b>X</b>	X		<b>X</b>	X			
Sanitize	<b>X</b>	X					<b>X</b>	X				
Handwash				X	<b>X</b>	X			<b>X</b>			
Woolens				X	<b>X</b>	X		<b>X</b>	X	X	X	X
Silk					<b>X</b>	X				<b>X</b>		
Custom	X	X	X	X	<b>X</b>	X	<b>X</b>	X	X	X	X	X
Extra White		<b>X</b>	X				<b>X</b>	X				
Delicates				X	<b>X</b>	X			<b>X</b>	X	X	X
Denim/Jeans				<b>X</b>	X	X		<b>X</b>	X			
Dress Shirts				<b>X</b>	X	X			<b>X</b>	X	X	X
Comforters				<b>X</b>	X	X		<b>X</b>	X	X		
Outerwear				<b>X</b>					<b>X</b>			
Table linens				<b>X</b>	X	X		<b>X</b>	X	X	X	X
Beach towels						<b>X</b>	<b>X</b>					
Express				X	<b>X</b>	X	<b>X</b>	X	X	X	X	X
Drain/Spin							<b>X</b>	X	X	X		X
Quick rinse								<b>X</b>	X	X	X	X

### Selectable Options except for buzzer

	Normal	Wrinkle-free	Sanitize	Handwash	Woolens	Silk	Custom	Extra White	Delicates	Denim/Jeans	Dress shirts	Comforters	Table linens
Heavy Soil	X	X	X	X			X	X		X	X	X	X
Extended	X	X	X	X			X	X	X	X		X	X
Sensitive	X	X	X	X	X	X	X	X	X	X	X	X	X

The default settings are highlighted in bold.

### Adding/removing laundry during a wash program

- Press the "Pause" button briefly.

The washer interrupts the program and unlocks the door.

- Open the drum door.
- Add or remove laundry.
- Close the door.
- Press the "Start" button.

The program continues automatically.

**Note:** Once the program has started the washer can not make adjustments of the load size.

### The drum door cannot be opened if:

- the water temperature is greater than **130°F (55°C)**.
- the water level is too high.
- the program has reached the "Final Spin".
- The Child Lock function is activated.

If you attempt to open the door while the washer is in one of the above statuses "Machine locked" will appear in the display.

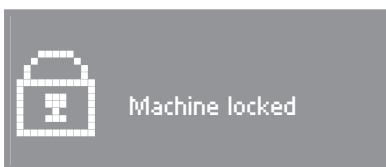

# Cleaning and Care

---

 Before cleaning or maintenance, disconnect the power supply by unplugging the unit or manually "tripping" the circuit breaker.

 Do not hose the washer down.

## Cleaning the exterior and control panel

- Clean the exterior of the washer with a mild solution of non-abrasive detergent or soap and water, and wipe dry with a soft cloth.
- Clean the drum with a stainless steel cleaner specially formulated for use in a washing machine, available from Miele.

 Do not use chemical solvents, abrasive cleaners, glass or all purpose cleaners! They will damage the surface.

## Cleaning the drum

Miele suggests running a "**maintenance cycle**" approx. once a month to ensure that your washing machine remains clean and free of any soil buildup or odors.

- **Do not** add laundry to the drum.
- Select the "Sanitize" program.
- Add 1/4 cup of detergent and/or bleach to the respective compartment (if desired).
- Run the program as normal through to completion.

## Desclaing the washer

If the correct amount of detergent is dispensed, the machine should not need to be descaled.

If the washer needs to be descaled, use a descaling agent with corrosion protection. These special descaling agents can be purchased from Miele. Use as directed on the packaging.



## Cleaning the detergent drawer

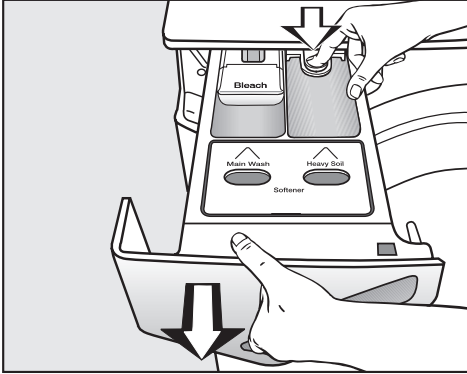

- Pull out the detergent drawer as far as it will go. Press down on the red release lever and pull the drawer out of the machine.
- Clean the detergent drawer with warm water.

Clean detergent residue regularly.

## Siphon tube and channel

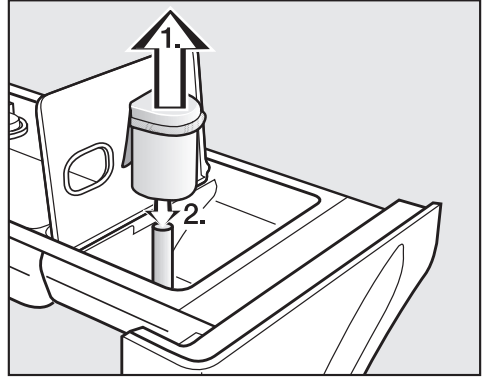

1. Remove the siphon tube from the "Softener" compartment and rinse under warm water. Also clean the pipe that the siphon tube is attached to.
2. Replace the siphon tube.

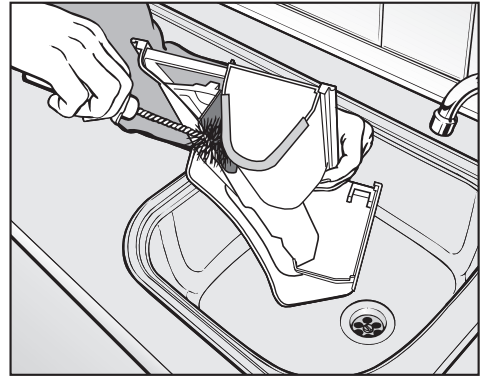

- Clean the fabric softener channel with warm water and a brush.

Clean the siphon tube and fabric softener channel more often when frequently using liquid starch. Liquid starch tends to stick.

## Cleaning and care

### Cleaning the water inlet filters

The washer has two water inlet filters to protect each inlet valve. These filters should be checked and cleaned if necessary every 6 months. This may need to be done more frequently with some water supplies.

- Turn off the water supply.
- Unscrew the inlet hose from the valve by turning the connector counter-clockwise using a wrench if necessary.

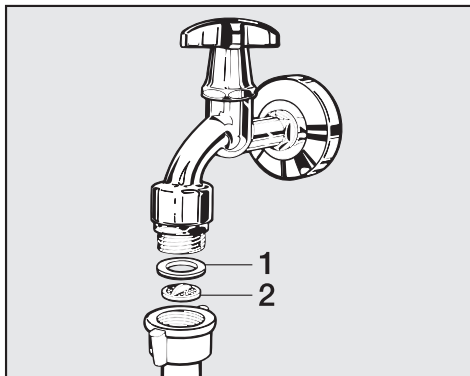

- Remove the rubber seal, **1**, from the connector.
- Using needle nose pliers, grasp the plastic filter, **2**, and pull it out of the hose connector.
- Clean the filter under running water and carefully remove any large particles.
- Replace the filter and seal then reconnect the hose.
- Slowly turn on the valve and check for leaks. If water leaks, tighten the bolt.

Both filters **must** be put back in place after cleaning.





## Frequently asked questions

 Repairs to electrical appliances must only be carried out by a qualified and trained person in accordance with local and national safety regulations. Repairs and other work by unqualified persons could be dangerous. The manufacturer cannot be held responsible for unauthorized work.

The following section will help you avoid placing a service call by identifying issues you may encounter while operating the machine:

<b>A wash program cannot be started</b>		
<b>Issue</b>	<b>Possible cause</b>	<b>Solution</b>
<b>The display stays blank and no indicator illuminates.</b>	The washer has no power.	Check to determine if: <ul style="list-style-type: none"><li>– the washer is plugged in.</li><li>– the circuit breaker has tripped.</li></ul>
<b>Immediately after the program start the washer cancels the program.</b>	The "child entrapment sensor" has reacted.	<ul style="list-style-type: none"><li>■ Open the drum door.</li><li>■ Check the drum.</li><li>■ Restart the program.</li></ul>

## Frequently asked questions

<b>The display shows a fault message</b>		
<b>Issue</b>	<b>Possible fault</b>	<b>Fix <sup>1)</sup></b>
 <b>Drain fault</b> <b>Check drain</b>	<ul style="list-style-type: none"> <li>– The drain is blocked.</li> <li>– The drain hose is too high.</li> </ul>	<ul style="list-style-type: none"> <li>– Clean the drain filter and the drain pump.</li> <li>– The maximum drain pump height is 3 ft (1m).</li> </ul>
 <b>Water inlet fault</b> <b>Open water faucet</b>	<ul style="list-style-type: none"> <li>– The water intake is blocked.</li> </ul>	Possible fault: <ul style="list-style-type: none"> <li>– check if the water supply is open all the way.</li> <li>– the inlet hose is kinked.</li> </ul>
 <b>Waterproof system activated</b>	The waterproof system has activated.	Call Technical Service.
 <b>Technical fault</b> <b>Call Technical Service</b>	There is a fault.	Restart the program. If the fault message appears again contact Technical Service.
In the display flashes <b>Anti-crease</b> alternating with <b>Check detergent</b>	The machine has oversudsed.	Use less detergent in the next wash program, and follow the recommended amount on the detergent packaging.

1) To turn off the fault message:

- To turn the fault message off: Open the drum door or press the "Pause" button until the fault message goes out.

## Frequently asked questions

<b>General problems with the washer</b>		
<b>Issue</b>	<b>Possible cause</b>	<b>Solution</b>
<b>The washer shakes during the spin cycle.</b>	The four feet are not resting evenly on the floor.	Level the machine (see "Leveling the washer").
<b>There are unusual sounds coming from the drain pump.</b>	There is no fault. Lapping sounds at the beginning and end of the drain process are normal.	
<b>Large residues of detergent remain in the dispenser drawer.</b>	The water pressure is too low.	Clean the water intake hose filter under running water and carefully remove any large particles.
	Water softeners tend to clump.	Clean the detergent drawer. In the future add the detergent first then the water softener.
<b>The fabric softener is not completely dispensed or too much water remains in the "Softener" compartment.</b>	The siphon tube is either positioned incorrectly or clogged.	Clean the siphon tube, see "Cleaning and care - Cleaning the detergent drawer".
<b>The display shows a foreign language.</b>	The display language was adjusted.	Select the display language. See "Setting the display language".

## Frequently asked questions

<b>Unsatisfactory wash results</b>		
<b>Issue</b>	<b>Possible cause</b>	<b>Solution</b>
<b>The laundry is not clean enough when using liquid detergent.</b>	Liquid detergents do not contain bleaching agents. Fruit, coffee and tea stains may not be removed.	<ul style="list-style-type: none"> <li>– Use powder detergents containing bleach.</li> <li>– Pre-treat stains</li> </ul>
<b>Laundry has a gray sticky residue.</b>	<ul style="list-style-type: none"> <li>– Not enough detergent was used to dissolve greasy deposits on heavily soiled laundry.</li> <li>– The laundry was soiled with grease, e.g. oils, lotions, etc.</li> </ul>	<ul style="list-style-type: none"> <li>– Add more detergent to laundry with grease stains or use a liquid detergent.</li> <li>– Run the "Sanitize" program without laundry using liquid detergent to clean the washer before using it for laundry again.</li> </ul>
<b>There is white detergent residue on dark laundry.</b>	The detergent has not completely dissolved because of hard water. These residues are difficult to remove.	<ul style="list-style-type: none"> <li>– After drying, remove white residues with a clothes brush.</li> <li>– In the future add a water softener to the detergent.</li> </ul>

## Frequently asked questions

<b>The drum door cannot be opened</b>	
<b>Possible cause</b>	<b>Solution</b>
<b>The door is locked during the wash cycles.</b>	Press the "Pause" button. The door lock opens.
<b>The Child Lock is activated.</b>	Deactivate the Child Lock as described in the chapter "Using the washer - Activate the Child Lock".
<b>Power failure</b>	Open the door as described on the following page.
<b>There is still water in the drum and the washer cannot drain the water.</b>	Clean the drain filter and drain pump. See "Cleaning and Care - Cleaning the drain pump and lint trap".
As a safeguard against scalding, the drum door cannot be opened if the wash water temperature is over 130°F (55°C).	

## Frequently asked questions

### Opening the drum door during a power failure or when the drain is blocked

 Pull the plug from the electrical outlet before cleaning the washer!

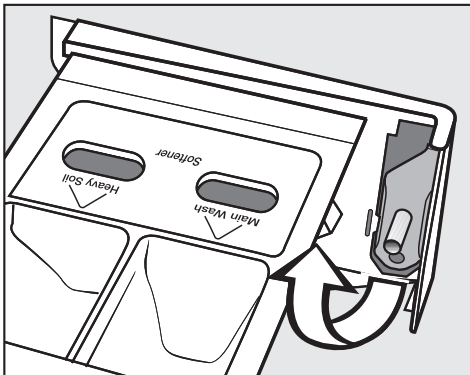

- Open the detergent dispenser drawer and remove the tool.

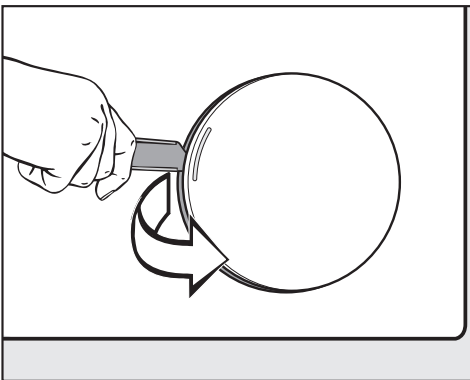

- Open the lint trap door.

If the drain is clogged there will be water in the machine (max. 9.25 gal [35 l]).

 Make sure the machine is turned off and the drum has stopped turning. A moving drum is dangerous.

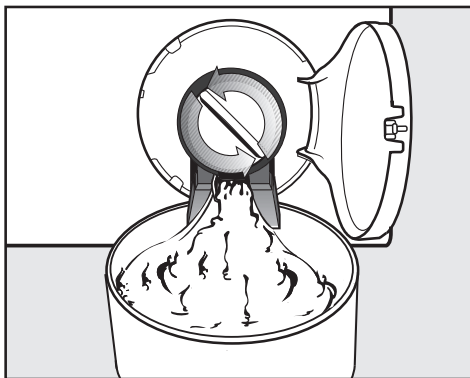

- Place a container under the drain tube.
- Open the drain filter until water runs out, but do not take it out completely.
- If the container becomes too full, interrupt the water flow by tightening the drain filter.
- Discard the water and continue.



## Frequently asked questions

Once the flow of water stops:

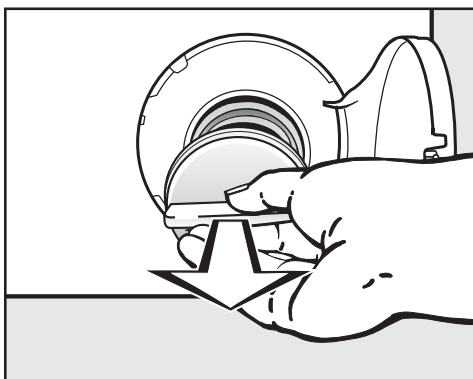

- Remove the drain filter.
- Clean out any foreign objects or lint from the filter.

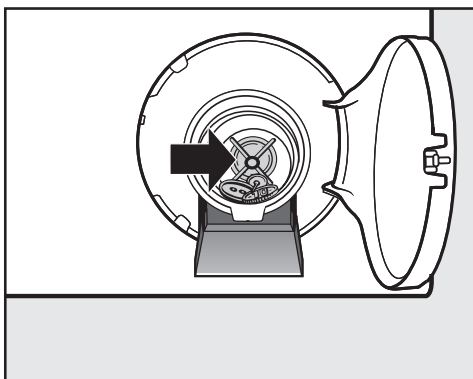

- Check that the drain pump impeller (in the back of the chamber) rotates freely by spinning it with your hand.
- Return the drain filter and tighten it into place.

 If the drain filter is not securely tightened water will leak out when the machine is used.

### Opening the drum door

 Make sure the machine is turned off and the drum has stopped turning. A moving drum is dangerous.

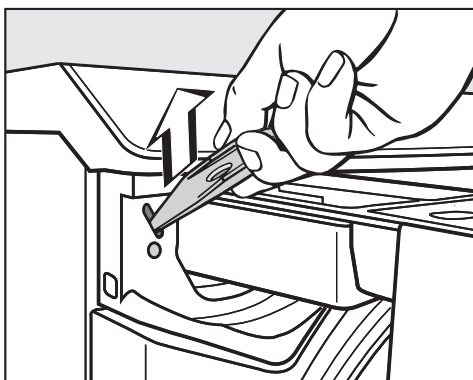

- Pull out the detergent drawer.
- Insert a screw driver into the slot of the emergency opener and pull upwards. The door will now open.

## After sales service

---

### Repairs

In the event of a fault which you cannot fix yourself, please contact the service number on the back of this manual.

When contacting the Service Department, please quote the model and serial number of your appliance. This information can be found on the data plate located at the door hinge.

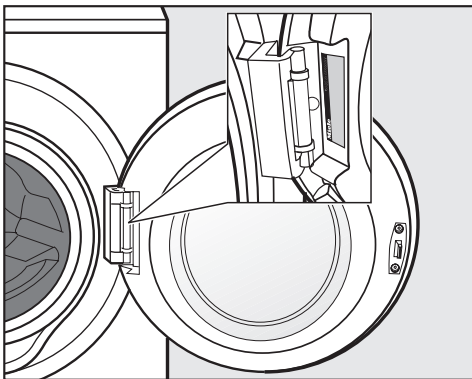

### PC Update

The indicator marked PC allows a technician to make use of new technology. When, for example, new programs are developed or new fabrics are introduced, a service technician will be able to modify existing program cycles accordingly.

Miele will provide information when such possibilities become available.

### Optional accessories

Optional accessories are available through your Miele dealer or Miele.

### MieleCare

(only USA)

**MieleCare**, our Extended Service Contract program; gives you the assurance of knowing that your appliance investment is covered by 5 years of worry free ownership.

**MieleCare** is the only Extended Service Contract in the industry that guarantees repairs by a Miele Authorized Service Provider using genuine Miele parts. Only genuine Miele parts installed by factory trained professionals can guarantee the safety, reliability and longevity of your Miele appliance.

Please note that unless expressly approved in writing by the Miele Service department, Extended Service Contracts offered by other providers for Miele products will not be recognized by Miele. Our goal is to prevent unauthorized (and untrained) service personnel from working on your Miele products, possibly doing further damage to them, you and/or your home.

To learn more about **MieleCare** Extended Service Contracts, please contact your appliance dealer or visit us online at:

<http://store.miele.com>

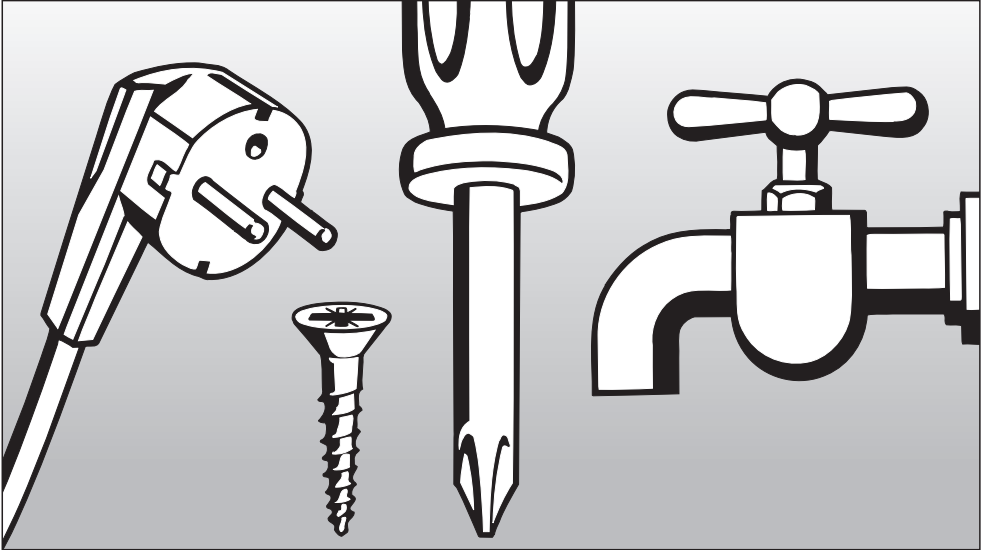

## Installation Instructions

To prevent accidents  
and machine damage  
read these instructions  
**before**  
installation or use.

# Installation

## Front view

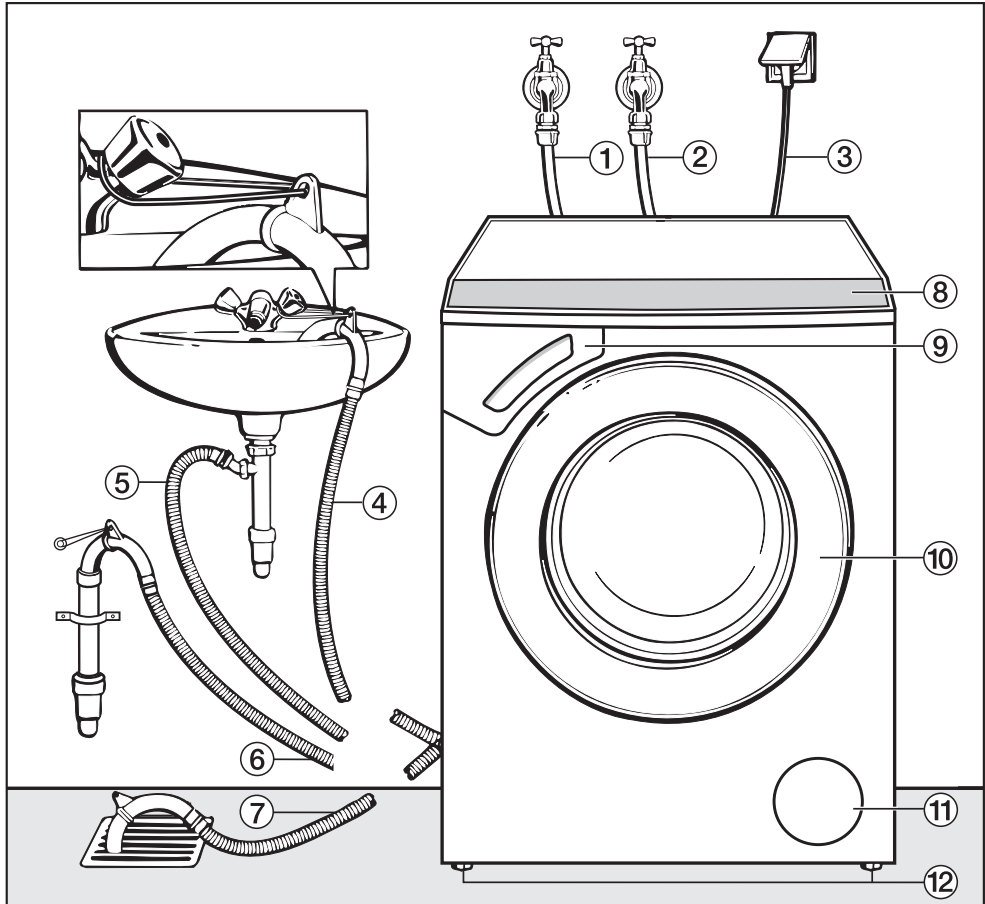

- ① High pressure intake hose, red mark for hot water
- ② High pressure intake hose, blue mark for cold water
- ③ Power cord
- ④ - ⑦ Flexible drain hose with detachable swivel elbow (drain options shown)
- ⑧ Control panel
- ⑨ Detergent dispenser drawer and door opener in case of power failure
- ⑩ Drum door
- ⑪ Access panel to lint trap and drain pump
- ⑫ Four height-adjustable feet

## Rear view

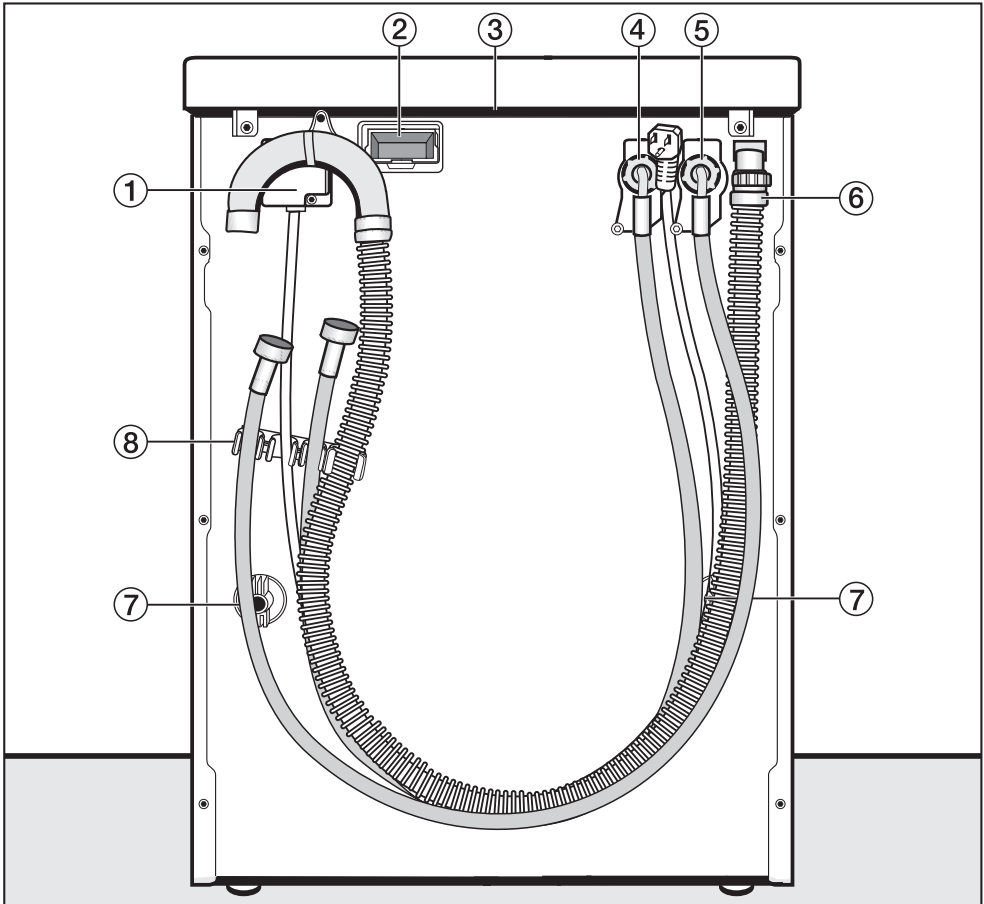

- ① Electrical connection
- ② W-LAN communication module
- ③ Rear access with grip for transport
- ④ Water intake hose cold water (blue stripes)
- ⑤ Water intake hose hot water (red stripes)
- ⑥ Drain hose
- ⑦ Shipping struts
- ⑧ Brackets for intake and drain hoses

# Installation

---

## Installation site

For best performance front loading washers should be installed on the ground floor or basement of the building.

A concrete or reinforced floor is the most suitable surface for the washer. These floors are less prone to vibration during the spin cycle.

If the installation must be on a wooden joist floor:

- the corner of a room where the stability of the floor is at its greatest is the best place to install the washer.
  - the machine must be leveled and securely positioned.
  - to avoid vibration while spinning, the machine should not be installed on soft floor coverings.
- Install the unit on a  $1\frac{1}{4}$ " (32 mm) thick, 28" x 31" (71x78 cm) wide plywood base. Ideally the base should be large enough to span several joists and should be anchored to the joists and not just the floor boards.

 If the machine is installed on a raised platform it must be secured with retaining clips available from your dealer or Miele. If installed on a masonry or concrete base, the base should have a  $\frac{1}{2}$ " (13 mm) to  $\frac{3}{4}$ " (19 mm) high rim. This must be done to prevent the washer from vibrating off the stand during the spin cycle.

## Installation

- Use the front washer feet and the rear excess end to transport the washer from its shipping pallet to the installation site.

**Do not lift the washer by the drum door!**

 Ensure that the machine's feet and the floor are dry to prevent slippage during the spin cycle.

## Removing the shipping struts

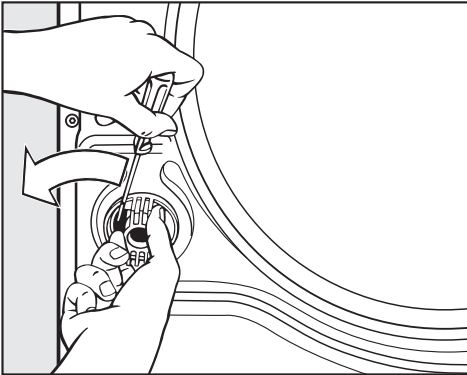

- Turn the left shipping strut counterclockwise 90°.

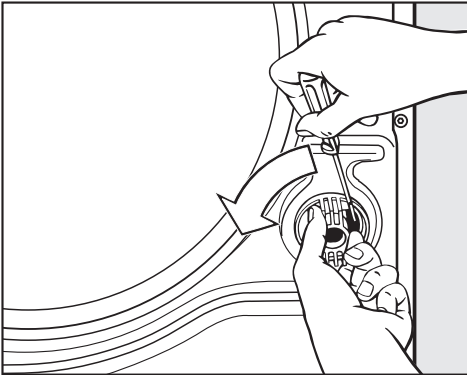

- Turn the right shipping strut counterclockwise 90°.

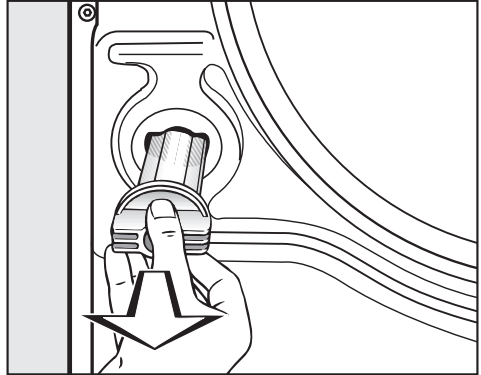

- Withdraw the two struts together with the support plate.

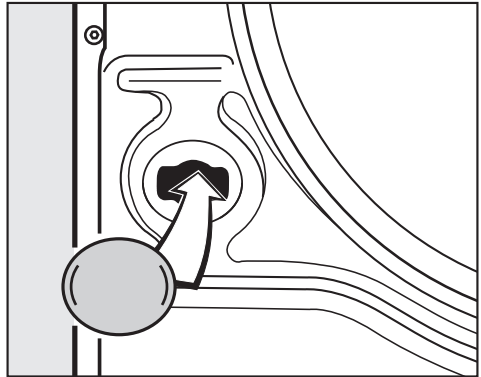

- Cover the two holes with the provided plugs.

 Movement of the washer without the shipping struts in place should be kept to a minimum. The struts must be reinstalled before the machine is moved. The shipping struts should be stored in a safe place for future use.

- Reinstall the struts by reversing the above procedure.

# Installation

## Leveling the washer

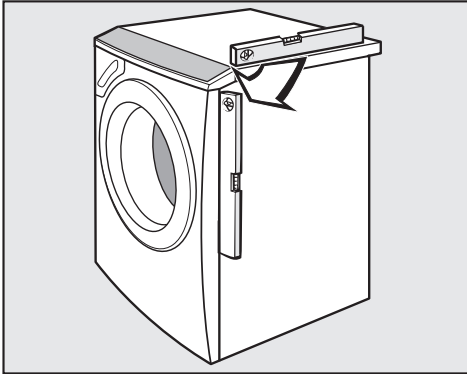

To ensure smooth operation the washer must be level.

Failure to level the machine can result in increased water and energy consumption, loud noises during the spin cycle or "walking" across the floor during use.

### Adjust the four leveling feet

The washer is leveled by adjusting the four feet. The machine is delivered with all four feet completely screwed in.

- Tip the machine slightly and place a support, such as a block of wood, underneath it.

**⚠ CAUTION:** The washer is extremely heavy. When tipping the machine be careful that it does not slip.

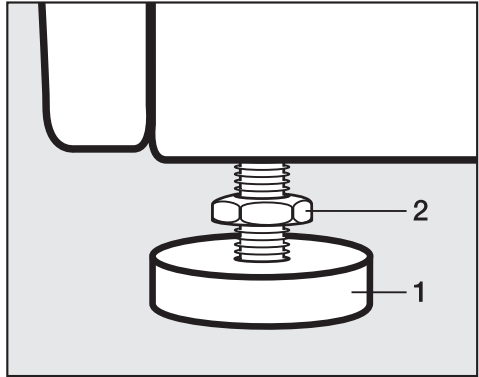

- Loosen the locking ring, **2**, with the supplied wrench.
- Unscrew each of the four feet as much as necessary by turning both the foot, **1**, and locking ring, **2**, to the left.
- Remove the support and stand the machine on its feet.
- Check that the machine stands level.
- Repeat the above procedure until the machine stands level.
- Once level, hold the foot, **1**, immobile with a wrench. At the same time, turn the locking ring, **2**, to the right using another wrench.

**⚠** All four locking rings must be tight against the bottom of the machine. In addition, check to see that the feet were not inadvertently unscrewed while tightening the rings. Operating a machine that is not level or whose feet are not tight may cause damage to both the machine and its surroundings.



The washing machine can be connected to a portable water supply. A non-return valve is not needed unless required by building code.

The washing machine has  $\frac{1}{2}$ " (13 mm) pressure hoses with  $\frac{3}{4}$ " (19 mm) female hose thread connections. If there is no water hookup, contact a plumber to install a connection. Make sure that the sealing ring is seated properly on the hose connector.

Replace the hose only with a genuine Miele hose, or with a hose able to withstand up to 145 psi (10 bar) pressure. The water valve connector must also be able to withstand 145 psi (10 bar).

 The bolted connection is under water pressure. Open the water supply slowly to check for leaks. Adjust the rubber seal and the bolted connection if necessary.

To protect the inlet valve, the two filters (one at the pressure hose / valve connection and one at the inlet connection to the solenoid valve) must not be removed.

## **Hose extension (optional accessory)**

Hose extensions with a length of 8'  $2\frac{7}{16}$ " to 13'  $1\frac{1}{2}$ " (2.5 to 4 m) are available from your Miele dealer or Miele.

# Plumbing

---

## Water connection

- Connect the cold water intake hose (blue mark) to the cold water valve and the hot water intake hose (red mark) to the hot water valve.

If the machine is being connected **only** to a cold water supply, both the hot and cold water intake hoses must be attached to the cold water valve through the use of a Y adapter (available at a hardware store). Both hoses **must** be connected to a water source or the machine will not function properly.

### **Do not connect the washer to hot water only.**

- Turn on the valve(s) and check for leaks. The water pressure must be within 15 -145 psi (1 -10 bar). If the water pressure is greater than 145 psi (10 bar) a pressure reducer must be installed. If the water pressure is below 15 psi (1 bar) there will not be enough water available for a complete fill.

The water intake hoses are equipped with screen filters. Do not remove these filters except for cleaning.

## Tips for a hot water connection

The hot water temperature from the hot water valve must not exceed 140°F (60°C); the ideal temperature is 130°F (55°C).

If there is no water pressure at the hot water inlet, the unit will automatically switch to cold water after several minutes.

## Drainage

The 5 foot (1.5 m) drain hose may be connected as follows:

- 1. Directly into a sink:** hook the hose over the edge of the sink and secure it firmly (e.g. by tying the hose to the water faucet).
- 2. To a stand pipe:** place the drain hose into a 1 ½" (4 cm) stand pipe and secure it firmly.
- 3. To a floor drain:** The machine is equipped with an air gap / anti-siphoning system so that no minimum drain height is required.

- The machine drains using a pump with a maximum delivery height of 4 feet (1.2 m).
- Make sure there are no kinks in the drain hose.

If desired, the drain hose may be extended to run a maximum of 16 feet (4.9 m), as long as the 4 foot (1.2 m) height is not exceeded. Hose extensions are available from your Miele dealer or Miele.

## Electrical connection

---

### GROUNDING INSTRUCTIONS

This appliance must be grounded. In the event of a malfunction or breakdown, grounding will reduce the risk of electric shock by providing a path of least resistance for electric current. This appliance is equipped with a cord having an equipment-grounding conductor and a grounding plug. The plug must be plugged into an appropriate outlet that is properly installed and grounded in accordance with all local codes and ordinances.

**WARNING** – Improper connection of the equipment-grounding conductor can result in a risk of electric shock. Check with a qualified electrician or service representative if you are in doubt as to whether the appliance is properly grounded.

Do not modify the plug provided with the appliance; if it will not fit the outlet, have a proper outlet installed by a qualified electrician.

The washing machine is supplied with a 5' (1.5 m) long, 3 wire cord, with a NEMA 5-15 P plug, ready for connection to a 120 V, 15 A, 60 Hz, AC power supply.

- Plug the machine into a proper outlet.
- If the plug does not fit, have a proper outlet installed by a qualified electrician.

## Setting the display language

---

The display language can be changed at any time as long as no program is running.

- Press the "Extended" button until the display shows:



- Select the desired language by pressing the left menu button "". Confirm with "**OK**".

The display is shown in the selected language.

# Help protect our environment

---

## **Disposal of the packing material**

The cardboard box and packing materials protect the appliance during shipping. They have been designed to be biodegradable and recyclable.

Ensure that any plastic wrappings, bags, etc. are disposed of safely and kept out of the reach of children, as they pose a danger of suffocation.

## **Disposal of an appliance**

Old appliances may contain materials that can be recycled. Please contact your local recycling center about the possibility of recycling these materials.

Ensure that the appliance presents no danger to children while being stored for disposal. Before discarding an appliance, unplug it from the outlet, cut off its power cord and remove any doors to prevent hazards.



**Please have the model and serial number  
of your appliance available before  
contacting Technical Service.**

---



**U.S.A.  
Miele, Inc.**

**National Headquarters**

9 Independence Way  
Princeton, NJ 08540  
Phone: 800-843-7231  
609-419-9898  
Fax: 609-419-4298  
[www.miele.com](http://www.miele.com)

**Technical Service & Support  
Nationwide**

Phone: 800-999-1360  
Fax: 888-586-8056  
[TechnicalService@mieleusa.com](mailto:TechnicalService@mieleusa.com)

**Canada  
Miele Limited**

**Headquarters and Showroom**

161 Four Valley Drive  
Vaughan, ON L4K 4V8  
Phone: 800-643-5381  
905-660-9936  
Fax: 905-532-2290  
[www.miele.ca](http://www.miele.ca)  
[info@miele.ca](mailto:info@miele.ca) (general enquiries)  
[professional@miele.ca](mailto:professional@miele.ca) (commercial  
enquiries)

**MieleCare National Service**

Phone: 800-565-6435  
905-532-2272  
Fax: 905-532-2292  
[service@miele.ca](mailto:service@miele.ca) (technical enquiries)